

# GS SERIES

## SUBMERSIBLE PUMPS FOR 4" WELLS

### APPLICATIONS

- Water supply.
- Sprinkler systems.
- Pressure boosting.
- Fire-fighting.
- Fountains.

### SPECIFICATIONS

- **Delivery** up to **21 m<sup>3</sup>/h.**
- **Head** up to **340 m.**
- **Maximum** pump overall **diameter** (cable cover included): **99 mm.**
- **Maximum** immersion **depth: 150 m.**
- Maximum permissible **quantity of suspended sand: 150 g/m<sup>3</sup>.**
- 1GSL - 2GS - 4GS - 6GS versions (radial impellers): 1 1/4" delivery port.
- 8GS - 12GS - 16GS versions (semi-axial impellers): 2" delivery port.
- Rated motor **power** from **0.25 to 7.5 kW.**
- Versions:
  - Single-phase** 220-230 V or 230-240 V, 50 Hz, from 0.25 to 2.2 kW.
  - Three-phase** 380-415 V, 50 Hz, from 0.37 to 7.5 kW.- Overload protection to be provided by user and installed in the control box (see control box section).- Maximum supply voltage variations: +6%/-10%
- Maximum number of **starts per hour**, at regular intervals: **30** (4OS motor), **20** (F4 motor).
- Horizontal operation up to 2.2 kW with 4OS or F4 series motors, with F4 motor for higher powers.
- Maximum **temperature** of water in contact with the motor: **30°C.**

### CONSTRUCTION CHARACTERISTICS

#### PUMP

- Abrasion resistant construction. The front wear plate, combined with the floating impellers, ensures optimum resistance to abrasion.
- The non-return valve is integrated in the head so as to



discharge the weight of the column of water and any water hammer onto the head itself, thus safeguarding impellers and diffusers.

- The upper and lower supports are made of precision-cast stainless steel, ensuring resistance to corrosion, durability and a sturdy coupling to the motor.
- The GS series pumps can be coupled to either 4OS or F4 motors.

#### MOTOR

For 4OS motor characteristics, please see specific section in this catalogue.

### TABLE OF MATERIALS

PART	MATERIAL
Upper head, Valve cap, Valve seat	STAINLESS STEEL (AISI 303 - DIN 1.4305)
Valve gasket	NITRILE RUBBER
Valve stop ring	STAINLESS STEEL (AISI 302 - DIN 1.4319)
Upper support	POLYCARBONATE/FIBERGLASS
Bearing	POLYURETHANE
Diffuser, impeller	POLYCARBONATE/FIBERGLASS
Diffuser case, Shim, Pump shaft, Outer sleeve, Spacer, Filter, Coupling, Cable cover	STAINLESS STEEL (AISI 304 - DIN 1.4301)

All the nitrile rubber, polyurethane and polycarbonate components are suitable for usage with foodstuffs and comply with FDA specification (the Food and Drug Administration is the US agency for the safeguard of public health).

## 1GSL, 2GS, 4GS, 6GS SERIES HYDRAULIC PERFORMANCE TABLE AT 2850 rpm, 50 Hz

PUMP TYPE	NUMBER OF STAGES	KW	HP	Q = DELIVERY														RATED CURRENT		CAPACITOR 450 V	ELECTRIC PUMP LENGTH mm	ELECTRIC PUMP WEIGHT kg	
				l/min	0	5	10	15	20	25	30	40	50	60	80	90	110	133	SINGLE-PHASE 220 V				THREE-PHASE 380-415 V
				m <sup>3</sup> /h	0	0,3	0,6	0,9	1,2	1,5	1,8	2,4	3	3,6	4,8	5,4	6,6	8					
H = TOTAL HEAD METERS COLUMN OF WATER																							
1GSL02M	8	0,25	0,33	53	50	44,5	36,5	26,5									2,5	-	12,5	632	11,5		
1GSL03M	12	0,37	0,5	79	75	66,5	55	40									3,5	-	16	722	13		
1GSL03T	12	0,37	0,5	79	75	66,5	55	40									-	1,1	-	701	12		
1GSL05M	18	0,55	0,75	119	112	100	83	60									4,5	-	20	854	15,5		
1GSL05T	18	0,55	0,75	119	112	100	83	60									-	1,6	-	826	14		
1GSL07M	24	0,75	1	159	150	133	110	80									5,7	-	30	981	17,5		
1GSL07T	24	0,75	1	159	150	133	110	80									-	2,1	-	959	16		
1GSL11M	35	1,1	1,5	232	218	194	160	116									8,2	-	40	1232	21		
1GSL11T	35	1,1	1,5	232	218	194	160	116									-	3	-	1203	20		
1GSL15M	49	1,5	2	324	305	272	224	163									10,5	-	50	1504	25		
1GSL15T	49	1,5	2	324	305	272	224	163									-	4	-	1476	23		
2GS02M	5	0,25	0,33	33				30	28	26	20	13					2,5	-	12,5	579	11		
2GS03M	7	0,37	0,5	47				42	40	36	29	19					3,5	-	16	634	12,5		
2GS03T	7	0,37	0,5	47				42	40	36	29	19					-	1,1	-	614	11		
2GS05M	10	0,55	0,75	67				60	56	52	41	27					4,5	-	20	714	14,5		
2GS05T	10	0,55	0,75	67				60	56	52	41	27					-	1,6	-	686	12,5		
2GS07M	14	0,75	1	93				83	79	73	57	37					5,7	-	30	806	16		
2GS07T	14	0,75	1	93				83	79	73	57	37					-	2,1	-	784	14,5		
2GS11M	20	1,1	1,5	133				119	113	104	82	53					8,2	-	40	940	18		
2GS11T	20	1,1	1,5	133				119	113	104	82	53					-	3	-	911	17		
2GS15M	28	1,5	2	187				167	158	146	115	74					10,5	-	50	1138	21		
2GS15T	28	1,5	2	187				167	158	146	115	74					-	4	-	1110	20		
2GS22M	40	2,2	3	267				238	226	208	164	106					15,9	-	70	1452	28		
2GS22T	40	2,2	3	267				238	226	208	164	106					-	5,9	-	1347	23		
2GS30T	52	3	4	347				309	294	271	213	138					-	7,8	-	1623	31		
4GS03M	4	0,37	0,5	27						24	23	21	19	13			3,5	-	16	598	12		
4GS03T	4	0,37	0,5	27						24	23	21	19	13			-	1,1	-	578	10,5		
4GS05M	7	0,55	0,75	47						42	40	37	33	22	15		4,5	-	20	691	14		
4GS05T	7	0,55	0,75	47						42	40	37	33	22	15		-	1,6	-	663	12		
4GS07M	9	0,75	1	60						54	51	47	42	28	19		5,7	-	30	756	15,5		
4GS07T	9	0,75	1	60						54	51	47	42	28	19		-	2,1	-	734	14		
4GS11M	14	1,1	1,5	94						84	80	74	66	44	30		8,2	-	40	893	17,5		
4GS11T	14	1,1	1,5	94						84	80	74	66	44	30		-	3	-	864	16		
4GS15M	19	1,5	2	127						114	108	100	89	60	40		10,5	-	50	1029	20		
4GS15T	19	1,5	2	127						114	108	100	89	60	40		-	4	-	1001	18,5		
4GS22M	27	2,2	3	181						162	154	142	127	85	57		15,9	-	70	1336	26		
4GS22T	27	2,2	3	181						162	154	142	127	85	57		-	5,9	-	1231	22		
4GS30T	35	3	4	228						204	194	179	160	107	72		-	7,8	-	1471	29		
4GS40T	48	4	5,5	322						288	274	252	226	151	102		-	10	-	2065	35		
6GS05M	5	0,55	0,75	30						26	25	22	21	17	12		4,5	-	20	710	14,5		
6GS05T	5	0,55	0,75	30						26	25	22	21	17	12		-	1,6	-	682	12,5		
6GS07M	7	0,75	1	43						36	35	31	29	24	16		5,7	-	30	794	16		
6GS07T	7	0,75	1	43						36	35	31	29	24	16		-	2,1	-	772	14,5		
6GS11M	10	1,1	1,5	61						52	49	44	41	34	23		8,2	-	40	916	18		
6GS11T	10	1,1	1,5	61						52	49	44	41	34	23		-	3	-	887	16,5		
6GS15M	14	1,5	2	85						72	69	62	58	48	32		10,5	-	50	1106	21		
6GS15T	14	1,5	2	85						72	69	62	58	48	32		-	4	-	1078	19,5		
6GS22M	21	2,2	3	128						108	104	93	87	71	48		15,9	-	70	1428	28		
6GS22T	21	2,2	3	128						108	104	93	87	71	48		-	5,9	-	1323	23		
6GS30T	29	3	4	177						150	143	128	120	99	67		-	7,8	-	1630	31		
6GS40T	38	4	5,5	232						196	188	168	157	129	87		-	10	-	2223	37		
6GS55T	52	5,5	7,5	317						268	257	230	215	177	120		-	13,7	-	2657	46		

Performances in compliance with ISO 9906 – Annex A  
Diameter of pump delivery port: 1GSL – 2GS – 4GS – 6GS: 1 1/2".

GS

## 8GS, 12GS, 16GS SERIES HYDRAULIC PERFORMANCE TABLE AT 2850 rpm, 50 Hz

PUMP TYPE	NUMBER OF STAGES	kW	HP	Q = DELIVERY												RATED CURRENT		CAPACITOR 450 V	ELECTRIC PUMP LENGTH mm	ELECTRIC PUMP WEIGHT kg	
				H = TOTAL HEAD METERS COLUMN OF WATER												SINGLE-PHASE 220 V	THREE-PHASE 380-415 V				
				l/min	60	80	100	120	140	160	200	250	300	367	m <sup>3</sup> /h						3,6
8GS07M	4	0,75	1	26	24	23	22	20	18	16							5,7	-	30	703	15
8GS07T	4	0,75	1	26	24	23	22	20	18	16							-	2,1	-	681	13,5
8GS11M	6	1,1	1,5	39	36	34	33	31	28	24							8,2	-	40	794	16,5
8GS11T	6	1,1	1,5	39	36	34	33	31	28	24							-	3	-	765	15,5
8GS15M	8	1,5	2	52	48	46	44	41	37	32							10,5	-	50	884	18,5
8GS15T	8	1,5	2	52	48	46	44	41	37	32							-	4	-	856	17
8GS22M	13	2,2	3	84	77	74	71	67	60	51							15,9	-	70	1144	25
8GS22T	13	2,2	3	84	77	74	71	67	60	51							-	5,9	-	1039	20
8GS30T	17	3	4	110	101	97	93	87	78	67							-	7,8	-	1268	28
8GS40T	23	4	5,5	149	137	132	126	118	106	91							-	10	-	1768	33
8GS55T	32	5,5	7,5	207	191	183	175	164	147	127							-	13,7	-	2039	40
8GS75T	43	7,5	10	279	256	246	235	220	198	170							-	19,8	-	2430	47
12GS15M	7	1,5	2	43			37	35	33	30	25	17					10,5	-	50	1000	19,5
12GS15T	7	1,5	2	43			37	35	33	30	25	17						4	-	972	18
12GS22M	10	2,2	3	61			53	50	47	43	36	24					15,9	-	70	1299	26
12GS22T	10	2,2	3	61			53	50	47	43	36	24					-	5,9	-	1194	21
12GS30T	14	3	4	86			74	70	66	61	50	34					-	7,8	-	1468	29
12GS40T	19	4	5,5	116			100	95	89	83	68	46					-	10	-	1804	35
12GS55T	26	5,5	7,5	159			137	130	122	113	94	63					-	13,7	-	2275	43
12GS75T	35	7,5	10	215			184	175	164	152	126	85					-	19,8	-	2818	52
16GS22M	8	2,2	3	47				37	36	32	27	23	16				15,9	-	70	1247	26
16GS22T	8	2,2	3	47				37	36	32	27	23	16				-	5,9	-	1142	21
16GS30T	11	3	4	65				51	49	44	38	31	22				-	7,8	-	1413	29
16GS40T	15	4	5,5	89				70	67	60	51	43	30				-	10	-	1760	35
16GS55T	20	5,5	7,5	118				94	89	80	69	57	41				-	13,7	-	2245	43
16GS75T	28	7,5	10	165				131	125	112	96	80	57				-	19,8	-	2865	52

Performances in compliance with ISO 9906 – Annex A  
Diameter of pump delivery port: 8GS – 12GS – 16GS: 2".



## 1GSL SERIES OPERATING CHARACTERISTICS AT 2850 rpm 50 Hz

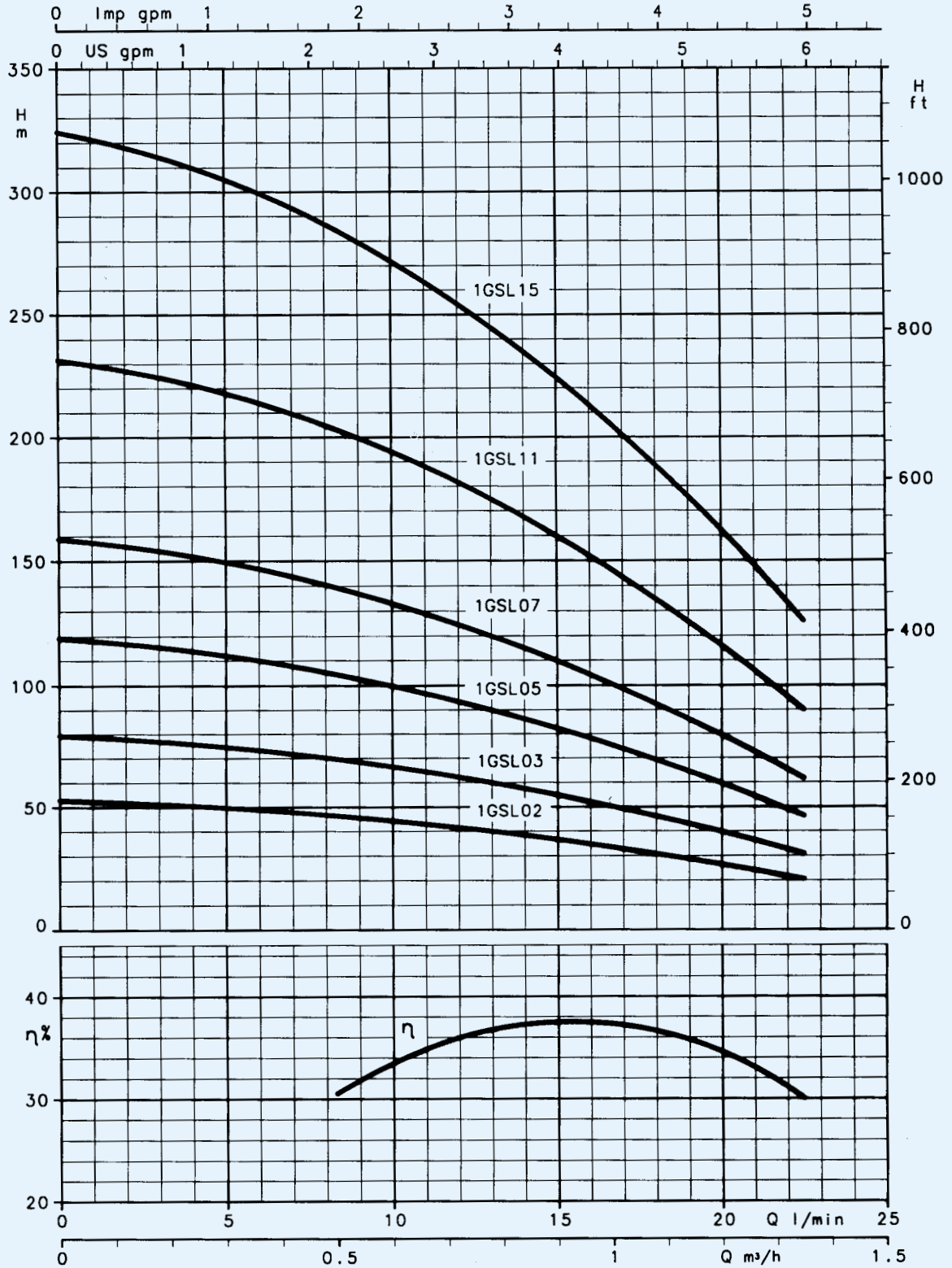

These performances are valid for liquids with density  $\rho = 1.0 \text{ kg/dm}^3$  and kinematic viscosity  $\gamma = 1 \text{ mm}^2/\text{sec}$ .

## 2GS SERIES OPERATING CHARACTERISTICS AT 2850 rpm 50 Hz

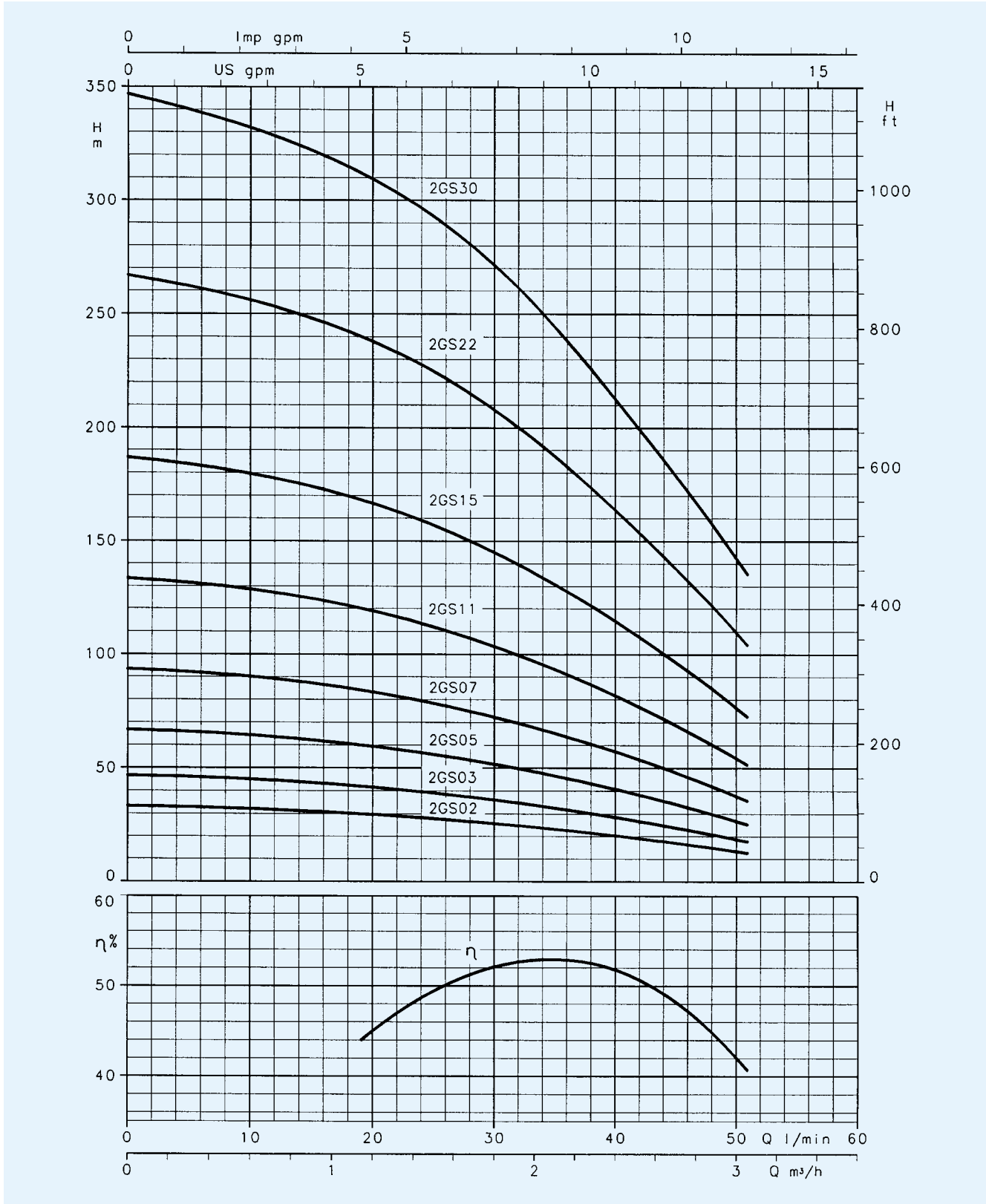

These performances are valid for liquids with density  $\rho = 1.0 \text{ kg/dm}^3$  and kinematic viscosity  $\gamma = 1 \text{ mm}^2/\text{sec}$ .



## 4GS SERIES OPERATING CHARACTERISTICS AT 2850 rpm 50 Hz

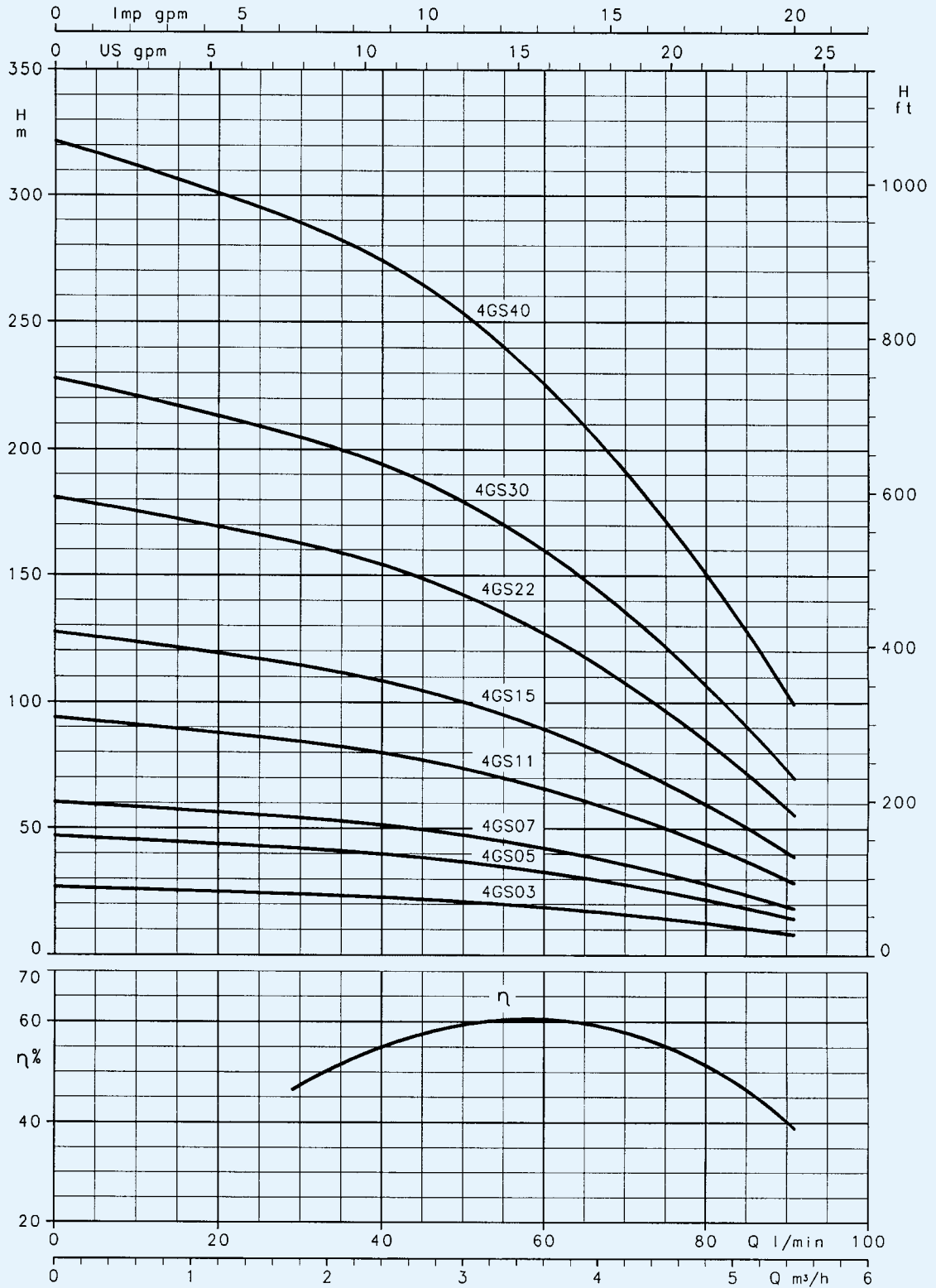

These performances are valid for liquids with density  $\rho = 1.0 \text{ kg/dm}^3$  and kinematic viscosity  $\gamma = 1 \text{ mm}^2/\text{sec}$ .

GS

## 6GS SERIES OPERATING CHARACTERISTICS AT 2850 rpm 50 Hz

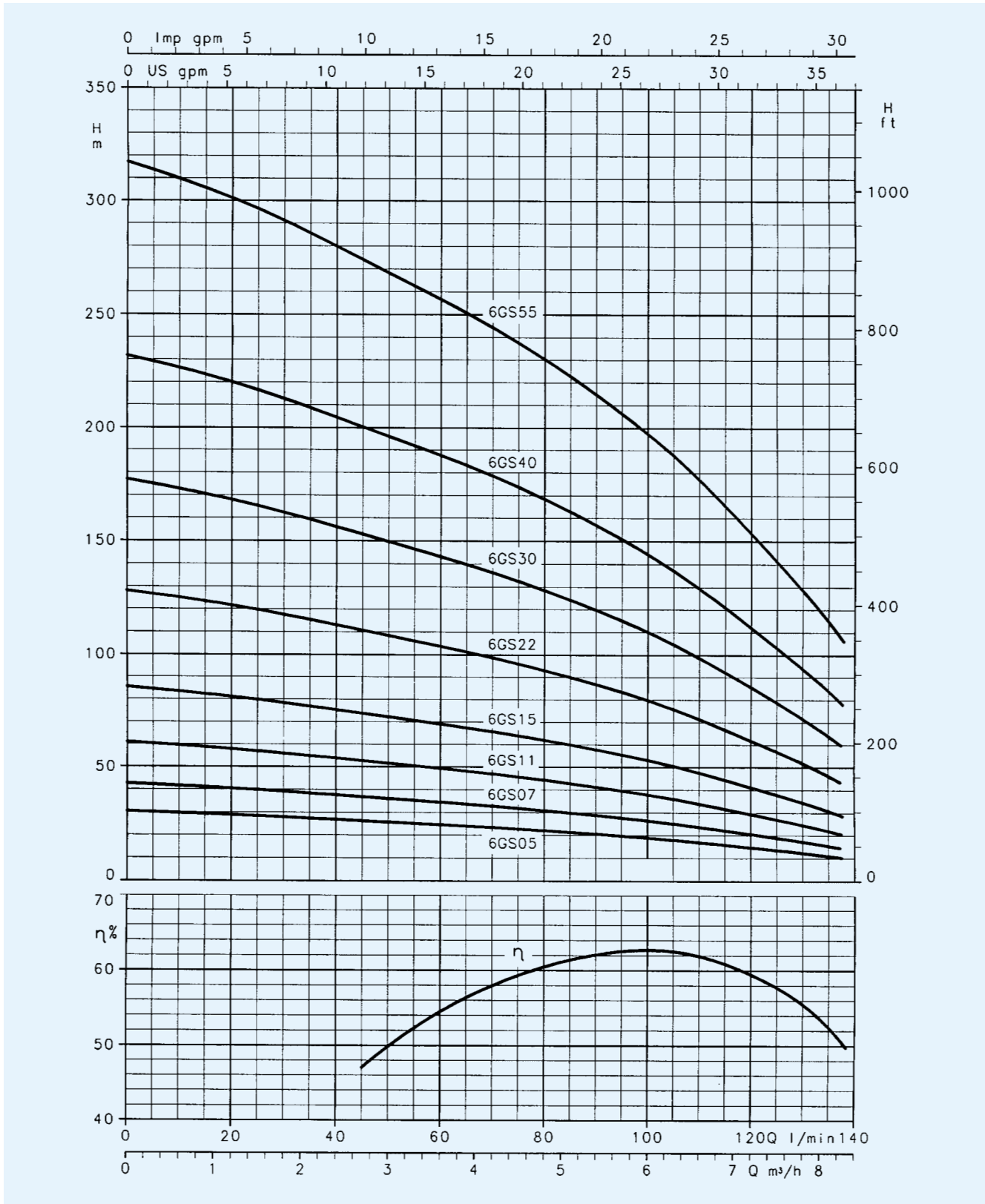

These performances are valid for liquids with density  $\rho = 1.0 \text{ kg/dm}^3$  and kinematic viscosity  $\gamma = 1 \text{ mm}^2/\text{sec}$ .



## 8GS SERIES OPERATING CHARACTERISTICS AT 2850 rpm 50 Hz

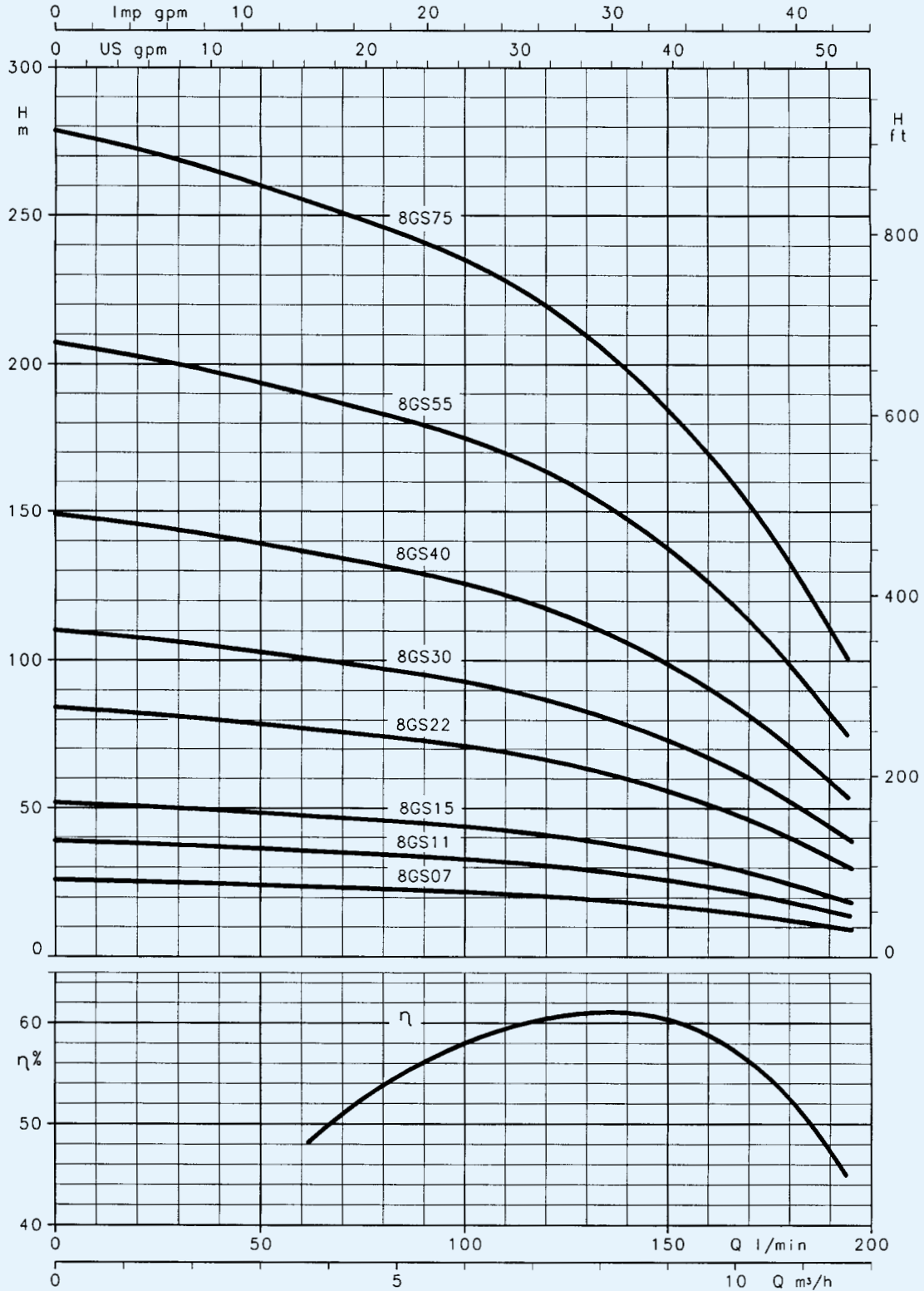

GS

These performances are valid for liquids with density  $\rho = 1.0 \text{ kg/dm}^3$  and kinematic viscosity  $\gamma = 1 \text{ mm}^2/\text{sec}$ .



**12GS SERIES  
 OPERATING CHARACTERISTICS AT 2850 rpm 50 Hz**

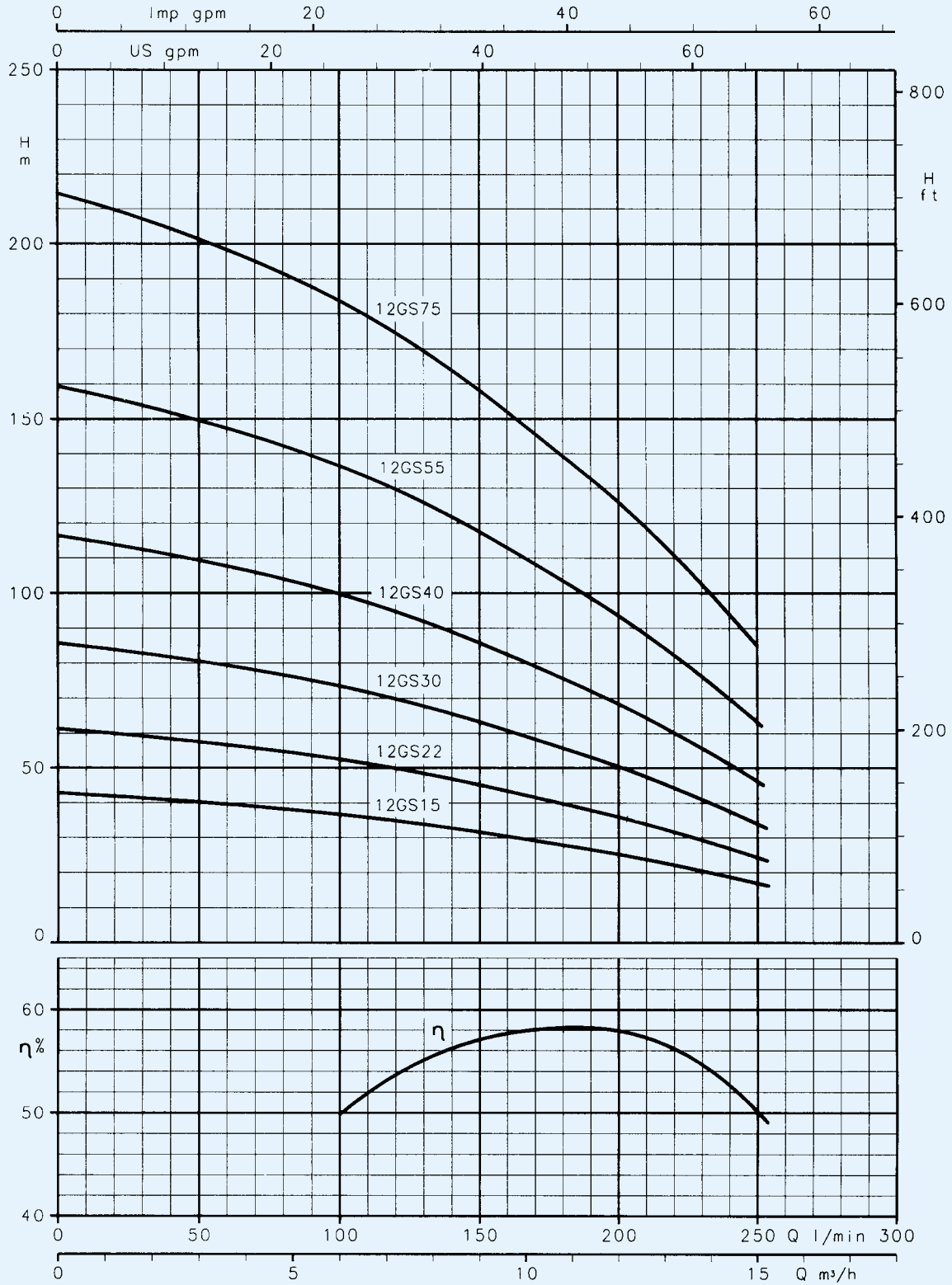

These performances are valid for liquids with density  $\rho = 1.0 \text{ kg/dm}^3$  and kinematic viscosity  $\gamma = 1 \text{ mm}^2/\text{sec}$ .



## 16GS SERIES OPERATING CHARACTERISTICS AT 2850 rpm 50 Hz

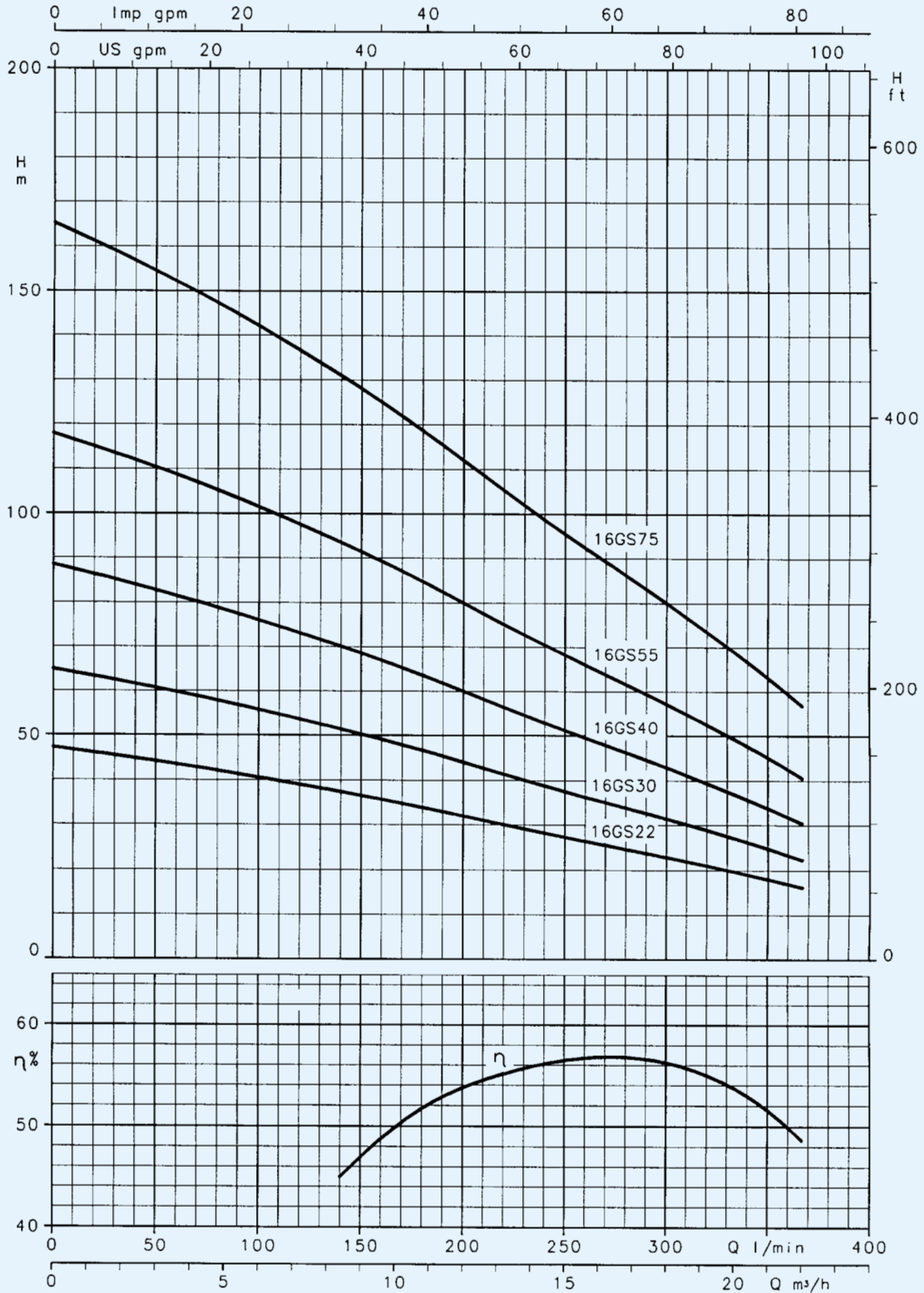

These performances are valid for liquids with density  $\rho = 1.0 \text{ kg/dm}^3$  and kinematic viscosity  $\gamma = 1 \text{ mm}^2/\text{sec}$ .

GS

## DIMENSIONS AND WEIGHTS, GS SERIES

PUMP TYPE	No. STAGES	DIMENSION L	DNM	WEIGHT kg
1GSL02	8	298	Rp 1" 1/4	3
1GSL03	12	367	Rp 1" 1/4	4
1GSL05	18	472	Rp 1" 1/4	5
1GSL07	24	577	Rp 1" 1/4	6
1GSL11	35	799	Rp 1" 1/4	8,5
1GSL15	49	1043	Rp 1" 1/4	11,5
2GS02	5	245	Rp 1" 1/4	2,5
2GS03	7	280	Rp 1" 1/4	3
2GS05	10	332	Rp 1" 1/4	3,5
2GS07	14	402	Rp 1" 1/4	4
2GS11	20	507	Rp 1" 1/4	5,5
2GS15	28	677	Rp 1" 1/4	7
2GS22	40	886	Rp 1" 1/4	9,5
2GS30	52	1095	Rp 1" 1/4	12
4GS03	4	244	Rp 1" 1/4	2,5
4GS05	7	309	Rp 1" 1/4	3
4GS07	9	352	Rp 1" 1/4	3,5
4GS11	14	460	Rp 1" 1/4	4,5
4GS15	19	568	Rp 1" 1/4	5,5
4GS22	27	770	Rp 1" 1/4	7,5
4GS30	35	943	Rp 1" 1/4	9
4GS40	48	1223	Rp 1" 1/4	12,5
6GS05	5	328	Rp 1" 1/4	3,5
6GS07	7	390	Rp 1" 1/4	4
6GS11	10	483	Rp 1" 1/4	5
6GS15	14	645	Rp 1" 1/4	7
6GS22	21	862	Rp 1" 1/4	9
6GS30	29	1102	Rp 1" 1/4	11,5
6GS40	38	1381	Rp 1" 1/4	14,5
6GS55	52	1815	Rp 1" 1/4	19
8GS07	4	299	Rp 2"	3
8GS11	6	361	Rp 2"	4
8GS15	8	423	Rp 2"	4,5
8GS22	13	578	Rp 2"	6
8GS30	17	740	Rp 2"	8
8GS40	23	926	Rp 2"	9,5
8GS55	32	1197	Rp 2"	12,5
8GS75	43	1538	Rp 2"	16
12GS15	7	539	Rp 2"	5
12GS22	10	733	Rp 2"	7,5
12GS30	14	940	Rp 2"	9,5
12GS40	19	1200	Rp 2"	12
12GS55	26	1556	Rp 2"	16
12GS75	35	2023	Rp 2"	20,5
16GS22	8	681	Rp 2"	7
16GS30	11	885	Rp 2"	9
16GS40	15	1156	Rp 2"	11,5
16GS55	20	1526	Rp 2"	15,5
16GS75	28	2070	Rp 2"	21

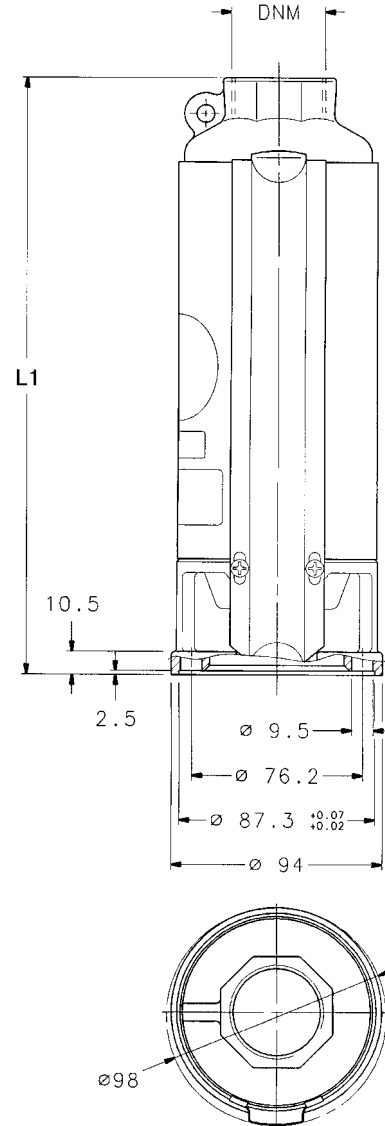

NOTE: for motor dimensions and weights see pages dedicated to 40S and F4 motors in this catalogue.

